

Schaerer Coffee Art Plus

Model SCA P C/T/S-1M (coffee, tea, Powersteam)

September 2007



Basic configuration

Spouts: coffee / hot water / Powersteam	1 / 1 / 1
Boiler: coffee (3kW) / hot water (3kW) / steam (3kW)	1 / 1 / 1
Grinders / DECAF functions	1 / 1
Steam selection	Powersteam
Programmable product selection	up to 36 different products

Connections

Voltage / power / fuse protection	400 V 3NAC, 9.3 kW, 16 A
Water connection / water outlet	G ½ "max 3 bar / Ø 36mm
Water hardness	5°-7° dh / 8°-12° fh

Dimensions

Width / depth / height	421 / 540 / 640 mm
Weight	about 40 kg

Output per hour (approximate)

Competence Centre	* Top quality according Schaerer Coffee
Espresso (cup of 50 - 60ml)	250 (CCC 175)*
Coffee (cup of 120ml)	200 (CCC 150)*
Cappuccino (cup of 180ml)	180 (CCC 150)*
Latte Macchiato (cup of 200ml)	160 (CCC 140)*
Hot milk with Milk Smart / cold milk with Cold milk system	160 / 150
Hot water (litre)	20

Options



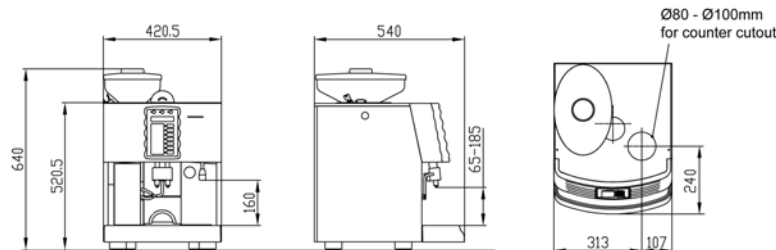

Autosteam, Supersteam, Finesteam
Lockable bean containers
Different milk systems usable
Water and waste water tank
Chute for coffee grounds under counter
Connection to all commercial invoicing systems
Cup warmer (Connections 230VAC / 10A)

Dimensions



Colours

Illustrations may not reflect actual colour

	Blue Mountain, blue
	Costa Rica, silver
	Brazil, bronze
	Kenya, black

Differences between the offered machine and the picture/configuration are possible.

M. Schaerer Ltd.
 Gewerbestrasse 15
 CH - 3302 Moosseedorf
 Phone +41 (0)31 858 51 11
 Fax +41 (0)31 858 51 40
 info@schaerer.com
 www.schaerer.com

schaerer
 coffee comes to life

SWISS MADE

Schaerer Coffee Art Plus

Model SCA P C/T/S-2M (coffee, tea, Powersteam)

September 2007



Basic configuration

Spouts: coffee / hot water / Powersteam	1 / 1 / 1
Boiler: coffee (3kW) / hot water (3kW) / steam (3kW)	1 / 1 / 1
Grinders / DECAF functions	2 / 1
Steam selection	Powersteam
Programmable product selection	up to 36 different products

Connections

Voltage / power / fuse protection	400 V 3NAC, 9.3 kW, 16 A
Water connection / water outlet	G ½ "max 3 bar / Ø 36mm
Water hardness	5°-7° dh / 8°-12° fh

Dimensions

Width / depth / height	421 / 540 / 640 mm
Weight	about 40 kg

Output per hour (approximate)

Competence Centre	* Top quality according Schaerer Coffee
Espresso (cup of 50 - 60ml)	250 (CCC 175)*
Coffee (cup of 120ml)	200 (CCC 150)*
Cappuccino (cup of 180ml)	180 (CCC 150)*
Latte Macchiato (cup of 200ml)	160 (CCC 140)*
Hot milk with Milk Smart / cold milk with Cold milk system	160 / 150
Hot water (litre)	20

Options



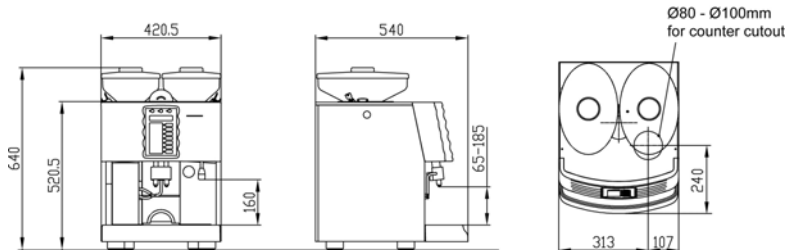

Autosteam, Supersteam, Finesteam
Lockable bean containers
Different milk systems usable
Water and waste water tank
Chute for coffee grounds under counter
Connection to all commercial invoicing systems
Cup warmer (Connections 230VAC / 10A)

Dimensions



Colours

Illustrations may not reflect actual colour

	Blue Mountain, blue
	Costa Rica, silver
	Brazil, bronze
	Kenya, black

Differences between the offered machine and the picture/configuration are possible.

M. Schaerer Ltd.
 Gewerbestrasse 15
 CH - 3302 Moosseedorf
 Phone +41 (0)31 858 51 11
 Fax +41 (0)31 858 51 40
 info@schaerer.com
 www.schaerer.com

schaerer
 coffee comes to life

SWISS MADE

Schaerer Coffee Art Plus

Model SCA P C/T-1M (coffee, tea)

September 2007



Basic configuration

Spouts: coffee / hot water	1 / 1
Boiler: coffee (3kW) / hot water (3kW)	1 / 1
Grinders / DECAF functions	1 / 1
Programmable product selection	up to 36 different products

Connections

Voltage / power / fuse protection	400 V 3NAC, 6.3 kW, 16 A
Water connection / water outlet	G ½ "max 3 bar / Ø 36mm
Water hardness	5°-7° dh / 8°-12° fh

Dimensions

Width / depth / height	421 / 540 / 640 mm
Weight	about 40 kg

Output per hour (approximate)

* Top quality according Schaerer Coffee

Competence Centre	
Espresso (cup of 50 - 60ml)	250 (CCC 175)*
Coffee (cup of 120ml)	200 (CCC 150)*
Hot water (litre)	20

Options



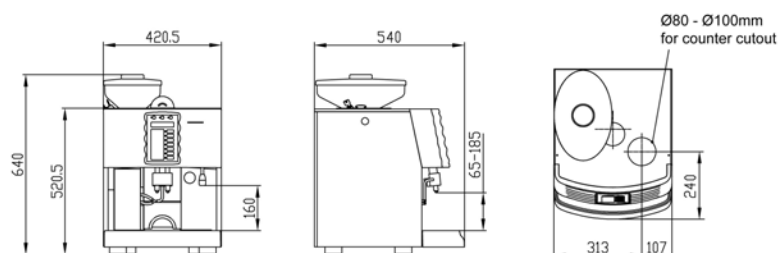

Lockable bean containers
Brewing accelerator
Different milk systems usable
Water and waste water tank
Waste water monitor
Chute for coffee grounds under counter
Connection to all commercial invoicing systems
Cup warmer (Connections 230VAC / 10A)

Dimensions



Colours

Illustrations may not reflect actual colour

	Blue Mountain, blue
	Costa Rica, silver
	Brazil, bronze
	Kenya, black

Differences between the offered machine and the picture/configuration are possible.

M. Schaerer Ltd.
 Gewerbestrasse 15
 CH - 3302 Moosseedorf
 Phone +41 (0)31 858 51 11
 Fax +41 (0)31 858 51 40
 info@schaerer.com
 www.schaerer.com

schaerer
 coffee comes to life

SWISS MADE

Schaerer Coffee Art Plus

Model SCA P C/T-2M (coffee, tea)

September 2007



Basic configuration

Spouts: coffee / hot water	1 / 1
Boiler: coffee (3kW) / hot water (3kW)	1 / 1
Grinders / DECAF functions	2 / 1
Programmable product selection	up to 36 different products

Connections

Voltage / power / fuse protection	400 V 3NAC, 6.3 kW, 16 A
Water connection / water outlet	G ½ "max 3 bar / Ø 36mm
Water hardness	5°-7° dh / 8°-12° fh

Dimensions

Width / depth / height	421 / 540 / 640 mm
Weight	about 40 kg

Output per hour (approximate)

* Top quality according Schaerer Coffee

Competence Centre	
Espresso (cup of 50 - 60ml)	250 (CCC 175)*
Coffee (cup of 120ml)	200 (CCC 150)*
Hot water (litre)	20

Options



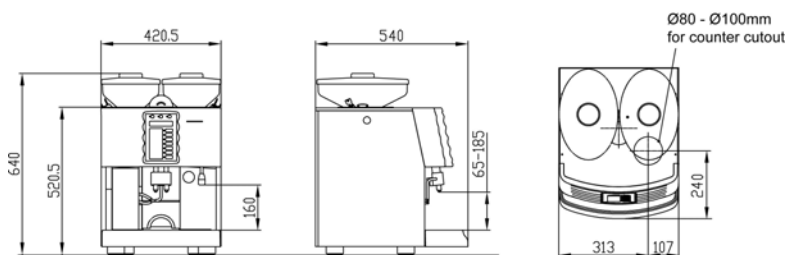

Lockable bean containers
Brewing accelerator
Different milk systems usable
Water and waste water tank
Waste water monitor
Chute for coffee grounds under counter
Connection to all commercial invoicing systems
Cup warmer (Connections 230VAC / 10A)

Dimensions



Colours

Illustrations may not reflect actual colour

	Blue Mountain, blue
	Costa Rica, silver
	Brazil, bronze
	Kenya, black

Differences between the offered machine and the picture/configuration are possible.

M. Schaerer Ltd.

Gewerbstrasse 15
CH - 3302 Moosseedorf
Phone +41 (0)31 858 51 11
Fax +41 (0)31 858 51 40
info@schaerer.com
www.schaerer.com

coffee comes to life

SWISS MADE

Schaerer Coffee Art

Model "CS" Cold Milk System

October 2008



Basic configuration

Removable milk tank with approx. 8-litre capacity

Pump support for milk fridge

1

Connections

Voltage / power / fuse protection

230 VAC, 0.07 kW, 10 A

Dimensions

Width / depth / height

260 / 564 / 470 mm

Weight

28 kg

Capacity

8 litre

Dimensions

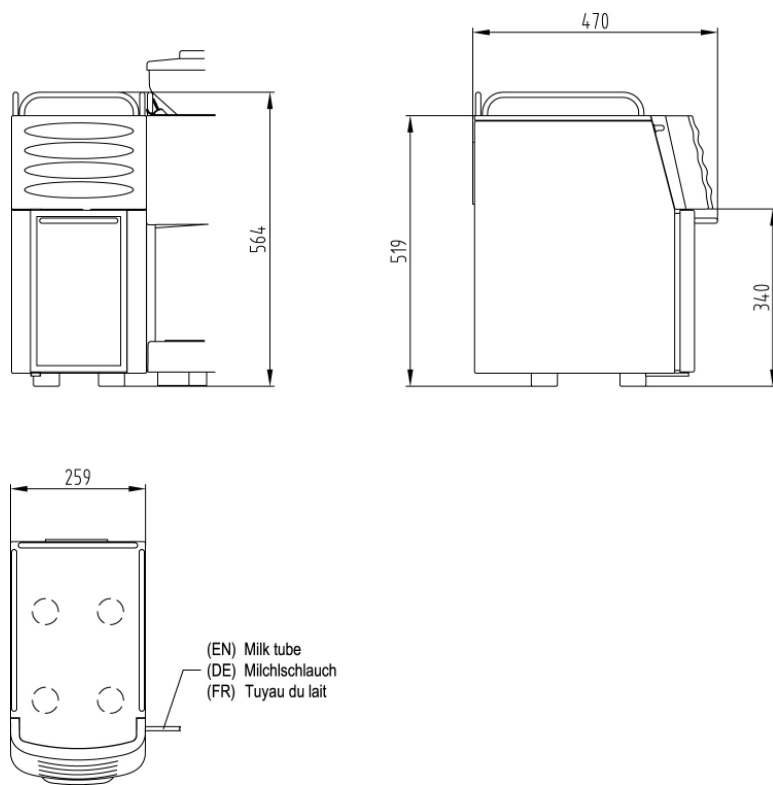

Differences between the offered machine and the picture/configuration are possible.

M. Schaerer Ltd.

Gewerbstrasse 15

CH – 3302 Moosseedorf

Phone +41 (0)31 858 51 11

Fax +41 (0)31 858 51 40

info@schaerer.com

www.schaerer.com

**schaerer**[®]
coffee comes to life

SWISS MADE

Schaerer Coffee Art

Modell "CM" Centre Milk

October 2008



Basic configuration

Removable milk tank	1 x 8 litres or 2 x 4 litres
Pump support for milk fridge	1

Connections

Voltage / power / fuse protection	230 VAC, 0.07 kW, 10 A
-----------------------------------	------------------------

Dimensions

Width / depth / height	260 / 564 / 470 mm
Weight	30 kg
Capacity	8 litres

Dimensions

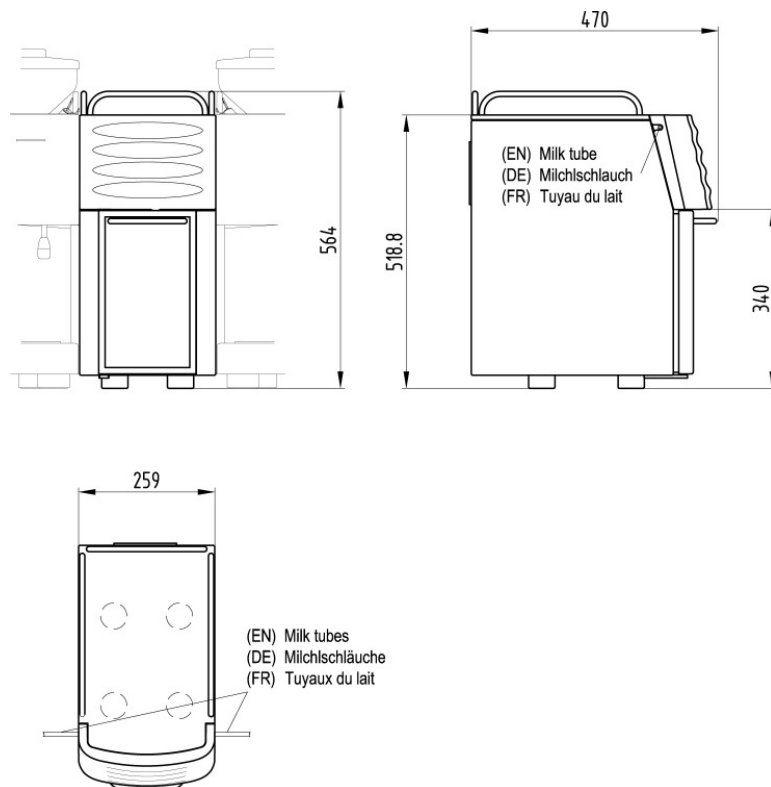

Differences between the offered machine and the picture/configuration are possible.

M. Schaerer Ltd.
Gewerbstrasse 15
CH - 3302 Moosseedorf
Phone +41 (0)31 858 51 11
Fax +41 (0)31 858 51 40
info@schaerer.com
www.schaerer.com

schaerer
coffee comes to life

SWISS MADE

Schaerer Coffee Art

Model "TW" Twin Milk

October 2008



Basic configuration

Removable milk tank	2 x 4 litres
Pump support for milk fridge	1

Connections

Voltage / power / fuse protection	230 VAC, 0.07 kW, 10 A
-----------------------------------	------------------------

Dimensions

Width / depth / height	260 / 564 / 470 mm
Weight	28 kg
Capacity	8 litres

Dimensions

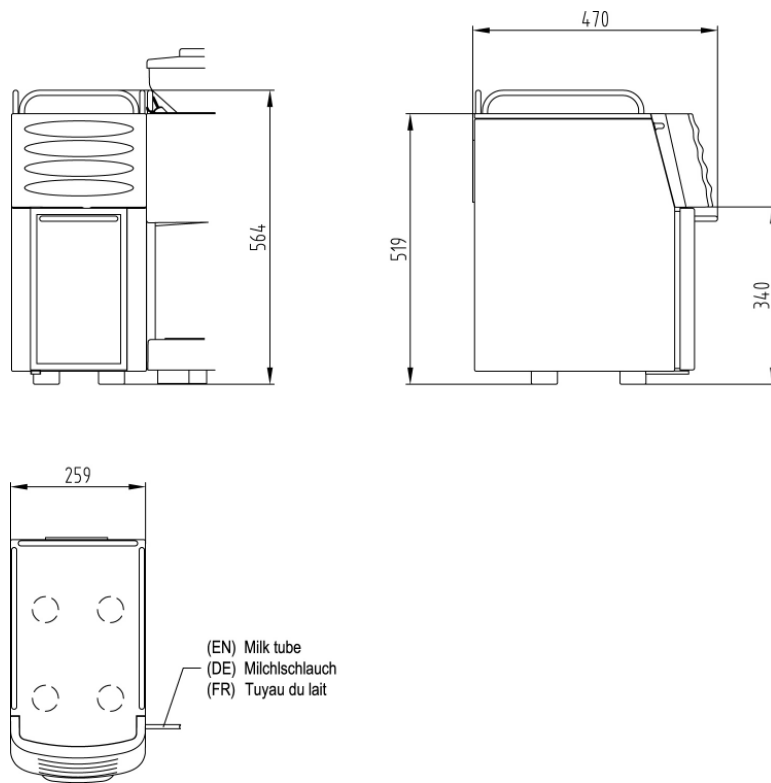

Differences between the offered machine and the picture/configuration are possible.

M. Schaerer Ltd.
Gewerbstrasse 15
CH - 3302 Moosseedorf
Phone +41 (0)31 858 51 11
Fax +41 (0)31 858 51 40
info@schaerer.com
www.schaerer.com

schaerer
coffee comes to life

SWISS MADE

Schaerer Coffee Art

Model "UC" Under Counter Milk

October 2008



Basic configuration

Removable milk tank	1 x 8 litres or 2 x 4 litres
Pump support for milk fridge	1

Connections

Voltage / power / fuse protection	230 VAC, 0.07 kW, 10 A
-----------------------------------	------------------------

Dimensions

Width / depth / height	260 / 519 / 470 mm
Weight	25 kg
Capacity	8 litres

Dimensions

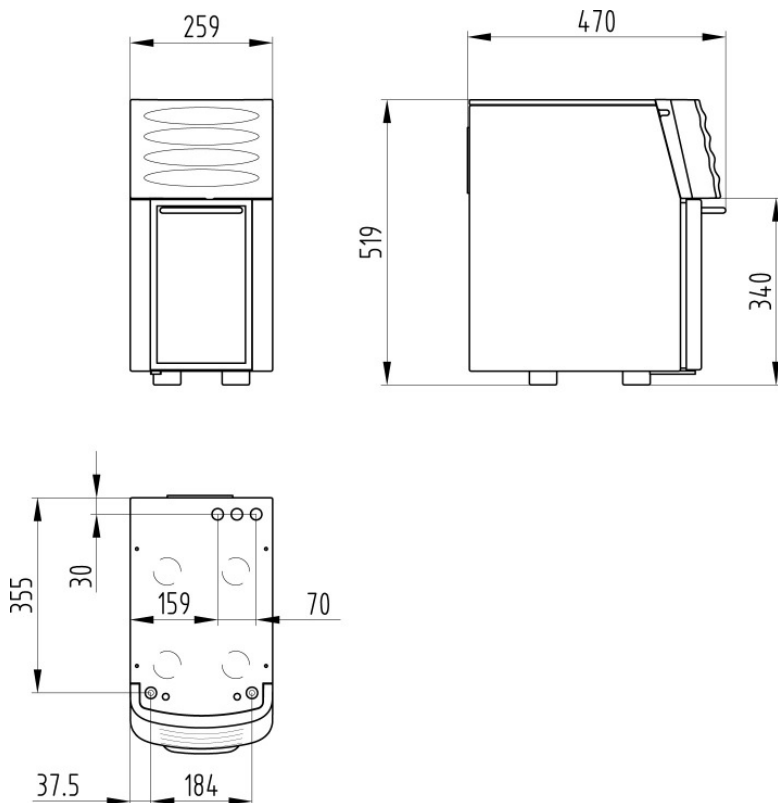

Differences between the offered machine and the picture/configuration are possible.

M. Schaerer Ltd.
Gewerbstrasse 15
CH - 3302 Moosseedorf
Phone +41 (0)31 858 51 11
Fax +41 (0)31 858 51 40
info@schaerer.com
www.schaerer.com

schaerer
coffee comes to life

SWISS MADE

Schaerer Coffee Art

Model Powder doser

February 2009



Basic configuration

Choco	1 x 1.0 kg Chocolate powder (1 type)
Topping	1 x 1.0 kg Milk powder (1 type)
Twin Choco	2 x 0.5 kg Chocolate powder (2 types)
Twin Topping	2 x 0.5 kg Milk powder (2 types)
Choco / Topping	2 x 0.5 kg Chocolate- and Milk powder

Connections

Voltage / power / fuse protection	24 VDC from coffee machine
-----------------------------------	----------------------------

Dimensions

Width / depth / height	140 / 451 / 690 mm
Weight	25 kg

Dimensions

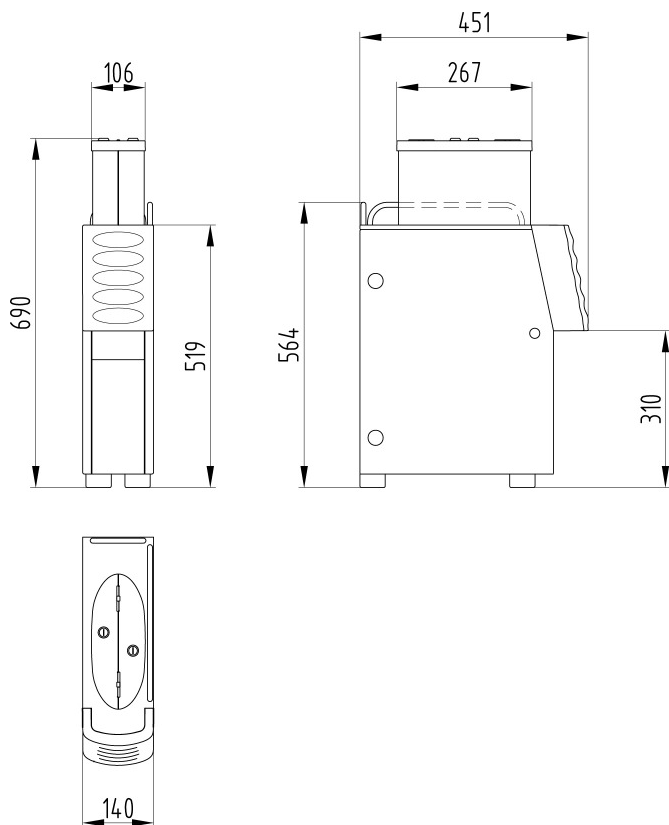

Differences between the offered machine and the picture/configuration are possible.

M. Schaerer Ltd.
Gewerbstrasse 15
CH - 3302 Moosseedorf
Phone +41 (0)31 858 51 11
Fax +41 (0)31 858 51 40
info@schaerer.com
www.schaerer.com



SWISS MADE

Schaerer Coffee Art

Model Cup & Cool

February 2009



Basic configuration

- Combined refrigerator unit and cup warmer
- Removable milk tank with approx. 4-litre capacity
- 3 heatable shelves made of uncoated stainless steel
- 2 separate on/off switches for cup warmer and accessory refrigerator unit
- Suitable for self-service

Connections

Voltage / power / fuse protection 230 VAC, 0.18 kW, 10 A

Dimensions

* depending on the size of the cups

Width / depth / height 272 / 524 / 385 mm
Weight 26.5 kg
Capacity about 45 - 140 cups* / 4 litre

Dimensions

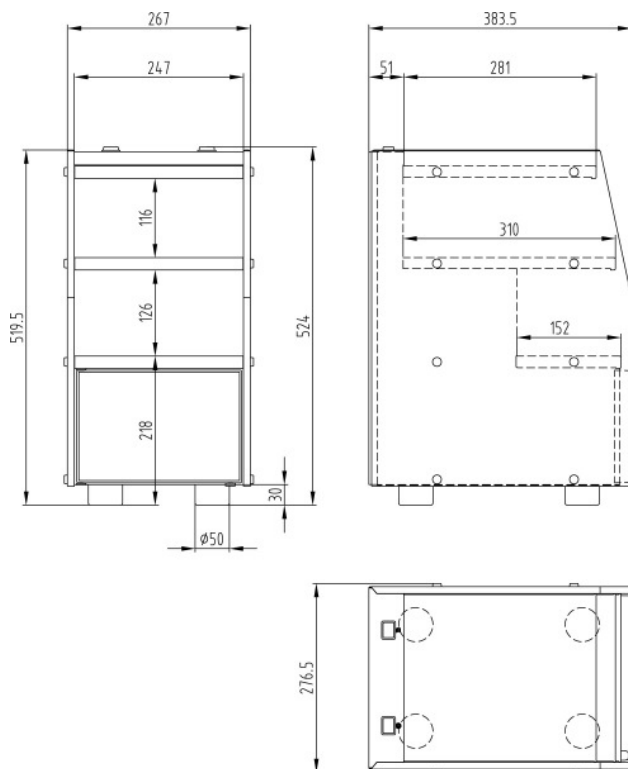

Differences between the offered machine and the picture/configuration are possible.

M. Schaerer Ltd.
Gewerbstrasse 15
CH - 3302 Moosseedorf
Phone +41 (0)31 858 51 11
Fax +41 (0)31 858 51 40
info@schaerer.com
www.schaerer.com

schaerer
coffee comes to life

SWISS MADE

Schaerer Coffee Art

Model "W" Cup warmer

Februar 2009



Basic configuration

4 heatable shelves made of perforated, uncoated stainless steel

Freely-adjustable thermostat

On/off switch

Suitable for self-service

Connections

Voltage / power / fuse protection

230 VAC, 0.12 kW, 10 A

Dimensions

* depending on the size of the cups

Width / depth / height

272 / 524 / 385 mm

Weight

18.5 kg

Capacity

about 60 - 260 cups*

Dimensions

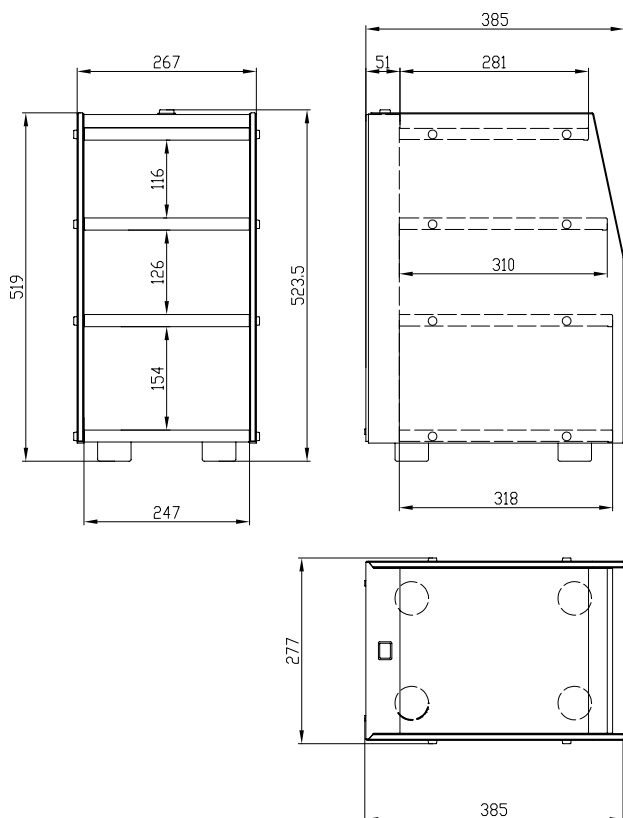

Differences between the offered machine and the picture/configuration are possible.

M. Schaerer Ltd.

Gewerbstrasse 15

CH - 3302 Moosseedorf

Phone +41 (0)31 858 51 11

Fax +41 (0)31 858 51 40

info@schaerer.com

www.schaerer.com

**schaerer**[®]
coffee comes to life

SWISS MADE