

# Schaerer Coffee Art

Model SCA 1 CT1-2M (coffee, tea)

September 2007



## Basic configuration

\* 3kW version not available in Switzerland

Spouts: coffee	1
Boiler: hot water (2 kW or 3 kW*)	1
Grinders / DECAF functions	2 / 1
Programmable product selection	up to 16 different products

## Connections

Voltage / power / fuse protection	230 VAC / 2.2 kW or 3.2 kW* / 10 A or 16 A*
Water connection / water outlet	G ½ " max 3 bar / Ø 36mm
Water hardness	5°-7° dh / 8°-12° fh

## Dimensions

Width / depth / height	421 / 540 / 640 mm
Weight	about 38 kg

## Output per hour (approximate)

\*\* Top quality according Schaerer Coffee Competence Centre

Espresso (cup of 50 - 60ml)	180 (CCC 175)**
Coffee (cup of 120ml)	150 (CCC 130)**
Cappuccino (cup of 180ml)	130 (CCC 120) **
Hot water (litre)	12

## Options



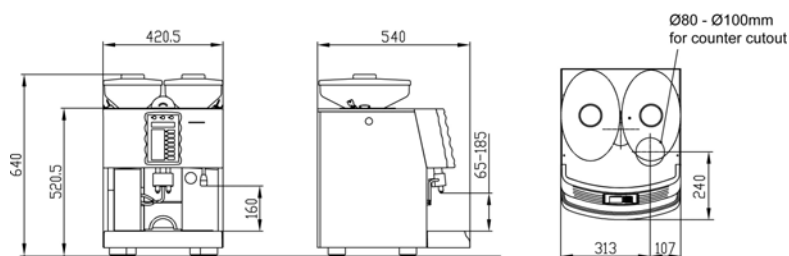

Lockable bean containers
Brewing accelerator
Selfservice panel
Water and waste water tanks
Waste water monitor
Chute for coffee grounds under counter
Connection to all commercial invoicing systems
Cup warmer (connections 230VAC / 10A)

## Dimensions



## Colours

Illustrations may not reflect actual colour

	Blue Mountain, blue
	Costa Rica, silver
	Brazil, bronze
	Kenya, black

Differences between the offered machine and the picture/configuration are possible.

M. Schaerer Ltd.  
Gewerbstrasse 15  
CH - 3302 Moosseedorf  
Phone +41 (0)31 858 51 11  
Fax +41 (0)31 858 51 40  
info@schaerer.com  
www.schaerer.com

  
coffee comes to life

SWISS MADE

# Schaerer Coffee Art

Model SCA 1 CT1/S-1M/S (coffee, tea, steam)

September 2007



## Basic configuration

\* 3kW version not available in Switzerland

Spouts: coffee	1
Boiler: hot water (2 kW or 3 kW*) / steam (2 kW or 3 kW*)	1 / 1
Grinders / DECAF functions	1 / 1
Programmable product selection	up to 16 different products

## Connections

Voltage / power / fuse protection	230 VAC / 2.2 kW or 3.2 kW* / 10 A or 16 A*
Water connection / water outlet	G ½ " max 3 bar / Ø 36mm
Water hardness	5°-7° dh / 8°-12° fh

## Dimensions

Width / depth / height	421 / 540 / 640 mm
Weight	about 38 kg

## Output per hour (approximate)

\*\* Top quality according Schaerer Coffee Competence Centre

Espresso (cup of 50 - 60ml)	180 (CCC 175)**
Coffee (cup of 120ml)	150 (CCC 130)**
Cappuccino (cup of 180ml)	130 (CCC 120)**
Hot water (litre)	12

## Options



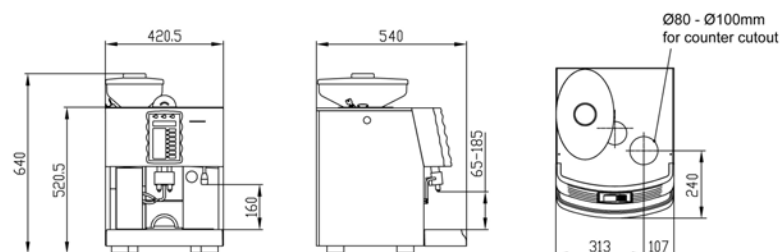

Lockable bean containers
Brewing accelerator
Selfservice panel
Water and waste water tanks
Waste water monitor
Chute for coffee grounds under counter
Connection to all commercial invoicing systems
Cup warmer (connections 230VAC / 10A)

## Dimensions



## Colours

Illustrations may not reflect actual colour

	Blue Mountain, blue
	Costa Rica, silver
	Brazil, bronze
	Kenya, black

Differences between the offered machine and the picture/configuration are possible.

M. Schaerer Ltd.  
 Gewerbestrasse 15  
 CH - 3302 Moosseedorf  
 Phone +41 (0)31 858 51 11  
 Fax +41 (0)31 858 51 40  
 info@schaerer.com  
 www.schaerer.com



SWISS MADE

# Schaerer Coffee Art

Model SCA 1 CT1/S-2M/S (coffee, tea, steam)

September 2007



## Basic configuration

\* 3kW version not available in Switzerland

Spouts: coffee	1
Boiler: hot water (2 kW or 3 kW*) / Steam (2 kW or 3 kW*)	1 / 1
Grinders / DECAF functions	2 / 1
Programmable product selection	up to 16 different products

## Connections

Voltage / power / fuse protection	230 VAC / 2.2 kW or 3.2 kW* / 10 A or 16 A*
Water connection / water outlet	G ½ " max 3 bar / Ø 36mm
Water hardness	5°-7° dh / 8°-12° fh

## Dimensions

Width / depth / height	421 / 540 / 640 mm
Weight	about 38 kg

## Output per hour (approximate)

\*\* Top quality according Schaerer Coffee Competence Centre

Espresso (cup of 50 - 60ml)	180 (CCC 175)**
Coffee (cup of 120ml)	150 (CCC 130)**
Cappuccino (cup of 180ml)	130 (CCC 120)**
Hot water (litre)	12

## Options

Lockable bean containers
Brewing accelerator
Selfservice panel
Water and waste water tanks
Waste water monitor
Chute for coffee grounds under counter
Connection to all commercial invoicing systems
Cup warmer (connections 230VAC / 10A)

## Dimensions

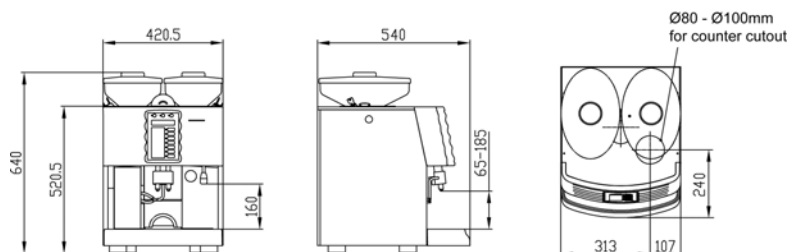

## Colours

Illustrations may not reflect actual colour

	Blue Mountain, blue
	Costa Rica, silver
	Brazil, bronze
	Kenya, black

Differences between the offered machine and the picture/configuration are possible.

M. Schaerer Ltd.  
 Gewerbestrasse 15  
 CH - 3302 Moosseedorf  
 Phone +41 (0)31 858 51 11  
 Fax +41 (0)31 858 51 40  
 info@schaerer.com  
 www.schaerer.com



SWISS MADE

# Schaerer Coffee Art

Model SCA 1 CT1/S-1M/L  
(coffee, tea, milk)

September 2007



## Basic configuration

\* 3kW version not available in Switzerland

Spouts: coffee	1
Boiler: hot water (2 kW or 3 kW*) / steam (2 kW or 3 kW*)	1 / 1
Grinders / DECAF functions	1 / 1
Programmable product selection	up to 16 different products

## Connections

Voltage / power / fuse protection	230 VAC / 2.2 kW or 3.2 kW* / 10 A or 16 A*
Water connection / water outlet	G ½ " max 3 bar / Ø 36mm
Water hardness	5°-7° dh / 8°-12° fh

## Dimensions

Width / depth / height	421 / 540 / 640 mm
Weight	about 38 kg

## Output per hour (approximate)

\*\* Top quality according Schaerer Coffee Competence Centre

Espresso (cup of 50 - 60ml)	180 (CCC 175)**
Coffee (cup of 120ml)	150 (CCC 130)**
Cappuccino (cup of 180ml)	130 (CCC 120)**
Latte Macchiato (cup of 200ml)	120 (CCC 110)**
Hot water (litre)	12

## Options



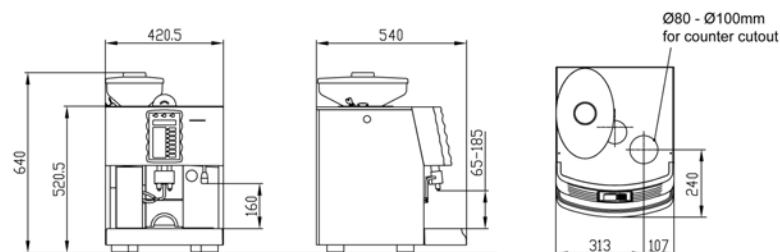

Lockable bean containers
Brewing accelerator
Additional steam spout for milk system
Water and waste water tank
Waste water monitor
Chute for coffee grounds under counter
Connection to all commercial invoicing systems
Cup warmer (Connections 230VAC / 10A)

## Dimensions



## Colours

Illustrations may not reflect actual colour

	Blue Mountain, blue
	Costa Rica, silver
	Brazil, bronze
	Kenya, black

Differences between the offered machine and the picture/configuration are possible.

M. Schaerer Ltd.  
Gewerbestrasse 15  
CH - 3302 Moosseedorf  
Phone +41 (0)31 858 51 11  
Fax +41 (0)31 858 51 40  
info@schaerer.com  
www.schaerer.com

  
coffee comes to life

# Schaerer Coffee Art

Model SCA 1 CT1/S-2M/L  
(coffee, tea, milk)

September 2007



## Basic configuration

\* 3kW version not available in Switzerland

Spouts: coffee	1
Boiler: hot water (2 kW or 3 kW*) / steam (2 kW or 3 kW*)	1 / 1
Grinders / DECAF functions	2 / 1
Programmable product selection	up to 16 different products

## Connections

Voltage / power / fuse protection	230 VAC / 2.2 kW or 3.2 kW* / 10 A or 16 A*
Water connection / water outlet	G ½ " max 3 bar / Ø 36mm
Water hardness	5°-7° dh / 8°-12° fh

## Dimensions

Width / depth / height	421 / 540 / 640 mm
Weight	about 38 kg

## Output per hour (approximate)

\*\* Top quality according Schaerer Coffee Competence Centre

Espresso (cup of 50 - 60ml)	180 (CCC 175)**
Coffee (cup of 120ml)	150 (CCC 130)**
Cappuccino (cup of 180ml)	130 (CCC 120)**
Latte Macchiato (cup of 200ml)	120 (CCC 110)**
Hot water (litre)	12

## Options

Lockable bean containers
Brewing accelerator
Additional steam spout for milk system
Water and waste water tank
Waste water monitor
Chute for coffee grounds under counter
Connection to all commercial invoicing systems
Cup warmer (connections 230VAC / 10A)

## Dimensions

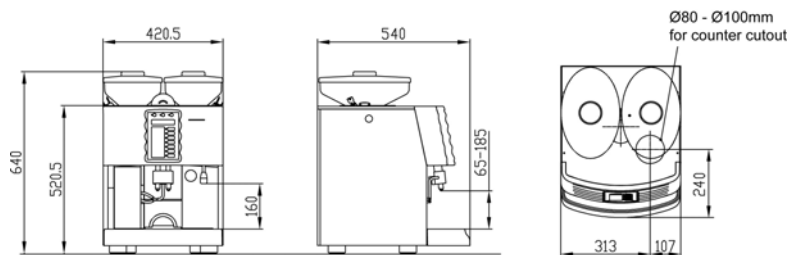

## Colours

Illustrations may not reflect actual colour

	Blue Mountain, blue
	Costa Rica, silver
	Brazil, bronze
	Kenya, black

Differences between the offered machine and the picture/configuration are possible.

M. Schaerer Ltd.  
Gewerbestrasse 15  
CH - 3302 Moosseedorf  
Phone +41 (0)31 858 51 11  
Fax +41 (0)31 858 51 40  
info@schaerer.com  
www.schaerer.com

  
coffee comes to life

# Schaerer Coffee Art

Model SCA 1 CT1-1M (coffee, tea)

September 2007



## Basic configuration

\* 3kW version not available in Switzerland

Spouts: coffee	1
Boiler: hot water (2 kW or 3 kW*)	1
Grinders / DECAF functions	1 / 1
Programmable product selection	up to 16 different products

## Connections

Voltage / power / fuse protection	230 VAC / 2.2 kW or 3.2 kW* / 10 A or 16 A*
Water connection / water outlet	G ½ " max 3 bar / Ø 36mm
Water hardness	5°-7° dh / 8°-12° fh

## Dimensions

Width / depth / height	421 / 540 / 640 mm
Weight	about 38 kg

## Output per hour (approximate)

\*\* Top quality according Schaerer Coffee Competence Centre

Espresso (cup of 50 - 60ml)	180 (CCC 175)**
Coffee (cup of 120ml)	150 (CCC 130)**
Cappuccino (cup of 180ml)	130 (CCC 120)**
Hot water (litre)	12

## Options



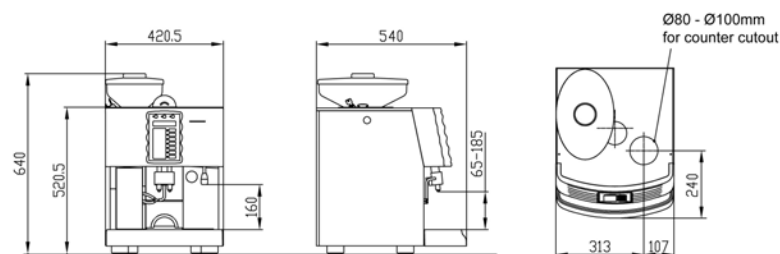

Lockable bean containers
Brewing accelerator
Selfservice panel
Water and waste water tanks
Waste water monitor
Chute for coffee grounds under counter
Connection to all commercial invoicing systems
Cup warmer (connections 230VAC / 10A)

## Dimensions



## Colours

Illustrations may not reflect actual colour

	Blue Mountain, blue
	Costa Rica, silver
	Brazil, bronze
	Kenya, black

Differences between the offered machine and the picture/configuration are possible.

M. Schaerer Ltd.  
 Gewerbestrasse 15  
 CH - 3302 Moosseedorf  
 Phone +41 (0)31 858 51 11  
 Fax +41 (0)31 858 51 40  
 info@schaerer.com  
 www.schaerer.com



SWISS MADE

# Schaerer Coffee Art

Model Powder doser

February 2009



## Basic configuration

Choco	1 x 1.0 kg Chocolate powder (1 type)
Topping	1 x 1.0 kg Milk powder (1 type)
Twin Choco	2 x 0.5 kg Chocolate powder (2 types)
Twin Topping	2 x 0.5 kg Milk powder (2 types)
Choco / Topping	2 x 0.5 kg Chocolate- and Milk powder

## Connections

Voltage / power / fuse protection	24 VDC from coffee machine
-----------------------------------	----------------------------

## Dimensions

Width / depth / height	140 / 451 / 690 mm
Weight	25 kg

## Dimensions

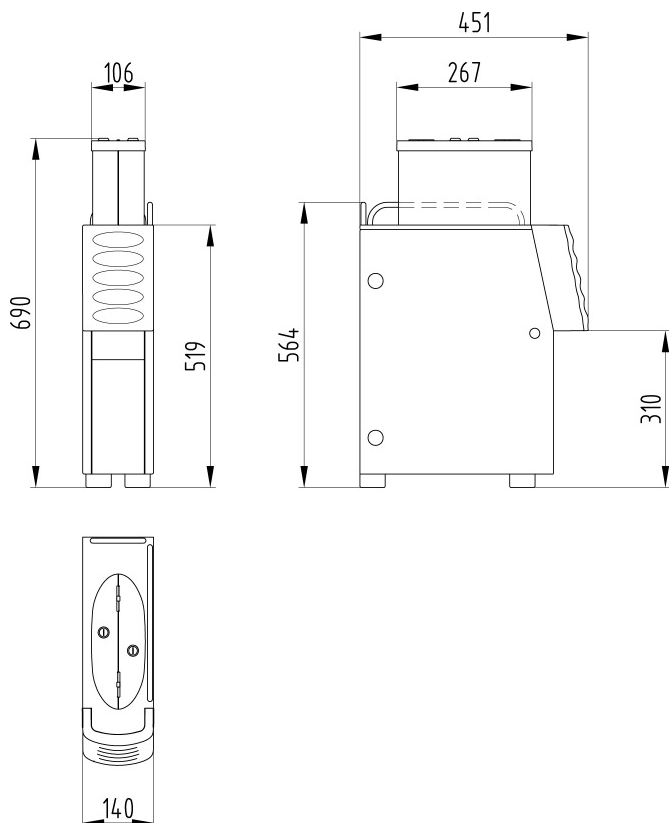

Differences between the offered machine and the picture/configuration are possible.

**M. Schaerer Ltd.**  
Gewerbstrasse 15  
CH - 3302 Moosseedorf  
Phone +41 (0)31 858 51 11  
Fax +41 (0)31 858 51 40  
info@schaerer.com  
www.schaerer.com



SWISS MADE

# Schaerer Coffee Art

Model "MSC" Milk Smart Cooler

February 2009



## Basic configuration

Removable milk tank with approx. 4-litre capacity

## Connections

Voltage / power / fuse protection 230 VAC, 0.07 kW, 10 A

## Dimensions

Width / depth / height 260 / 564 / 470 mm

Weight 28 kg

Capacity 4 litre

## Dimensions

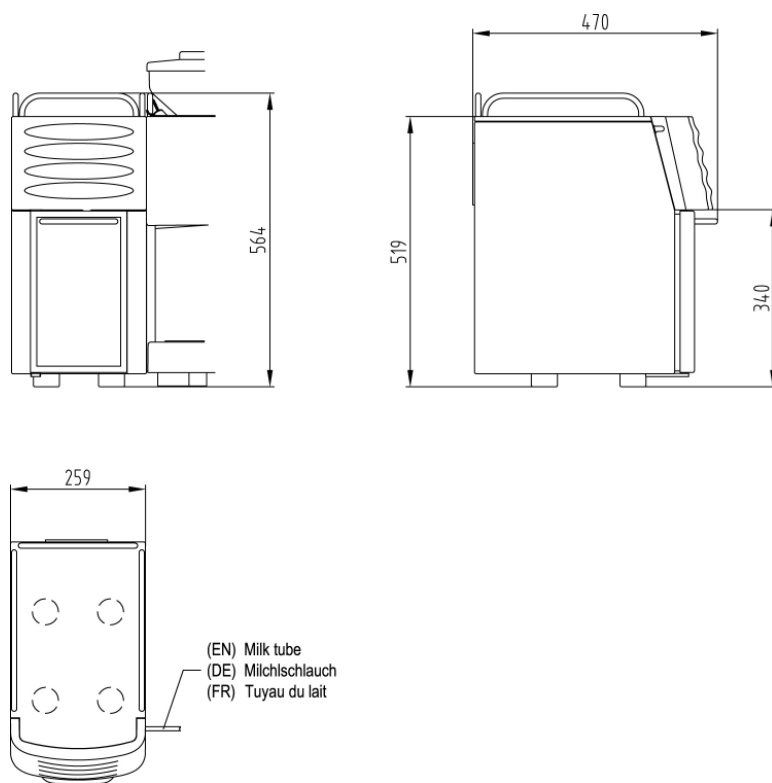

Differences between the offered machine and the picture/configuration are possible.

M. Schaerer Ltd.  
Gewerbstrasse 15  
CH - 3302 Moosseedorf  
Phone +41 (0)31 858 51 11  
Fax +41 (0)31 858 51 40  
info@schaerer.com  
www.schaerer.com

**schaerer**<sup>®</sup>  
coffee comes to life

SWISS MADE

# Schaerer Coffee Art

Model Cup & Cool

February 2009



## Basic configuration

- Combined refrigerator unit and cup warmer
- Removable milk tank with approx. 4-litre capacity
- 3 heatable shelves made of uncoated stainless steel
- 2 separate on/off switches for cup warmer and accessory refrigerator unit
- Suitable for self-service

## Connections

Voltage / power / fuse protection 230 VAC, 0.18 kW, 10 A

## Dimensions

\* depending on the size of the cups

Width / depth / height 272 / 524 / 385 mm  
Weight 26.5 kg  
Capacity about 45 - 140 cups\* / 4 litre

## Dimensions

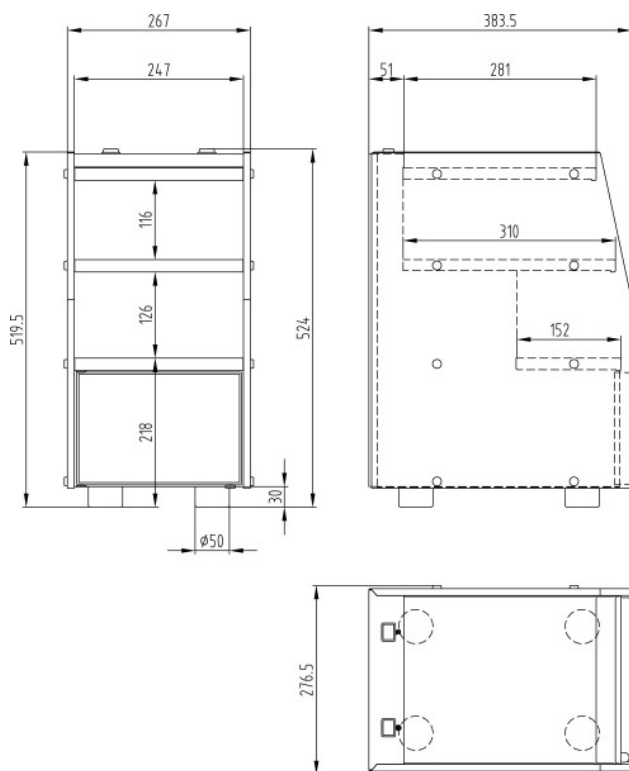

Differences between the offered machine and the picture/configuration are possible.

**M. Schaerer Ltd.**  
Gewerbstrasse 15  
CH - 3302 Moosseedorf  
Phone +41 (0)31 858 51 11  
Fax +41 (0)31 858 51 40  
info@schaerer.com  
www.schaerer.com

**schaerer**  
coffee comes to life

SWISS MADE

# Schaerer Coffee Art

Model "W" Cup warmer

Februar 2009



## Basic configuration

- 4 heatable shelves made of perforated, uncoated stainless steel
- Freely-adjustable thermostat
- On/off switch
- Suitable for self-service

## Connections

Voltage / power / fuse protection 230 VAC, 0.12 kW, 10 A

## Dimensions

\* depending on the size of the cups

Width / depth / height 272 / 524 / 385 mm

Weight 18.5 kg

Capacity about 60 - 260 cups\*

## Dimensions

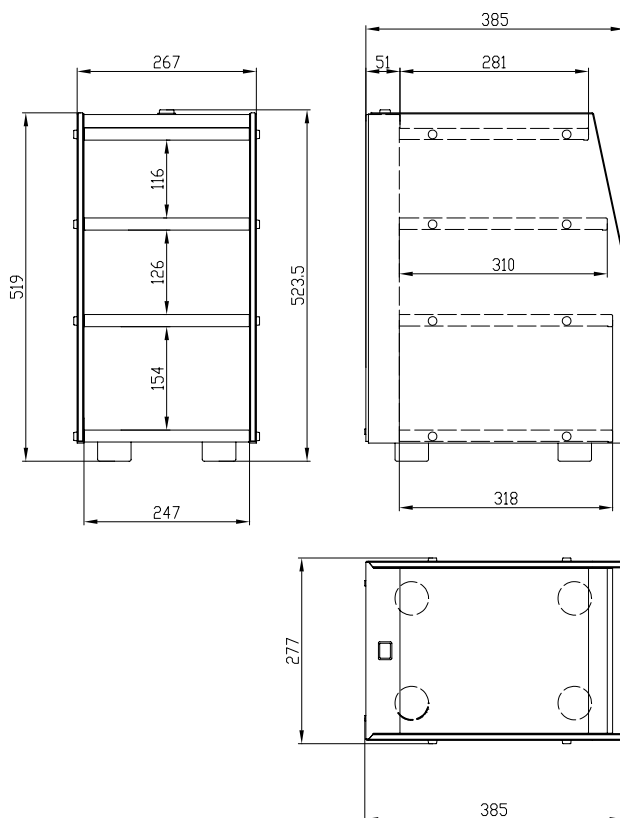

Differences between the offered machine and the picture/configuration are possible.

**M. Schaerer Ltd.**  
Gewerbstrasse 15  
CH - 3302 Moosseedorf  
Phone +41 (0)31 858 51 11  
Fax +41 (0)31 858 51 40  
info@schaerer.com  
www.schaerer.com

**schaerer**  
coffee comes to life

SWISS MADE